

Management vernetzter IT-Systeme

Kapitel: 9 Managementplattformen

Management Platforms - Contents

- Architecture of management platforms
- Infrastructure of a management platform
- User interface
- Basic application
- Selection criteria
- Development tools for management applications

Ansätze zur Realisierung von Mgmt.lösungen

Isolierter Ansatz

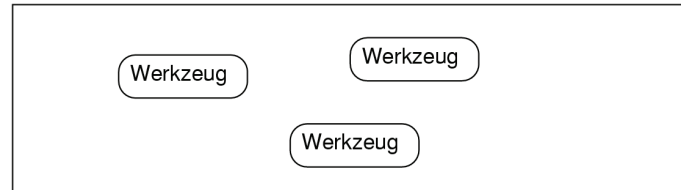

Koordination des
Werkzeug-Einsatzes

Koordinierter Ansatz

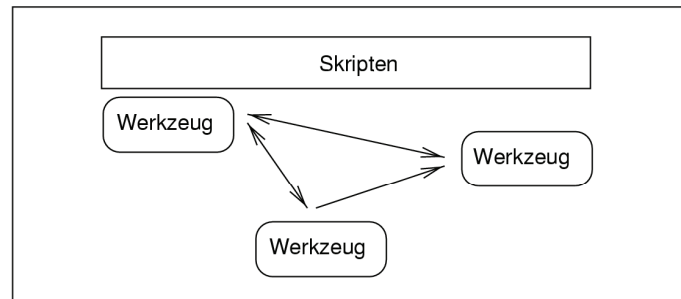

Verschmelzung der
Werkzeuge

Integrierter Ansatz

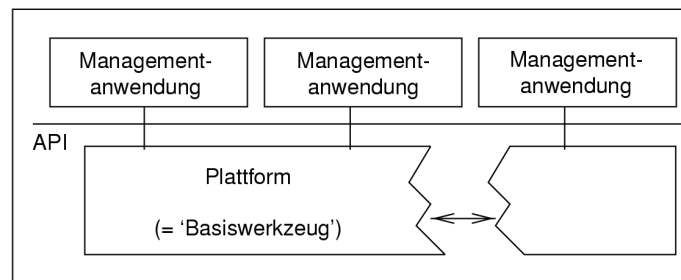

Management Platforms (1)

- Provide a uniform (management) view on distributed and heterogeneous resources
- Facilitate a comprehensive management of different resource classes
- Provide an infrastructure and an extensible run-time environment for management applications
- Often incorporate different management architectures (e.g., SNMP, OSI, DMTF)

Management Platforms (2)

- Have a modular structure, are implemented in a distributed fashion
- Are often based on OO modeling paradigms
- Provide defined interfaces, modules and APIs
- Separate resource managers from applications
- Provide GUIs (graphical user interfaces on X-Windows, MS-Windows) or are browser-based
- Not limited to management of resources from specific vendors
- Not limited to specific functional areas

Plattformen

- ❑ Plattformen implementieren Managementarchitekturen
- ❑ Plattformen sind Trägersysteme für Managementanwendungen

Mgmt-Architektur (Konzeptebene)	Plattformen (Implementierungsebene)
Kommunikationsmodell	Kommunikationsbaustein
Informationsmodell	Informationsverwaltung Datenbank MIB-Compiler, MIB-Browser
Funktionsmodell	Managementanwendungen Basisdienste
Organisationsmodell	verstreut über mehrere Bausteine
nicht beschrieben	Oberflächenbaustein

Plattformarchitektur

Managementsystem
(Managing System)

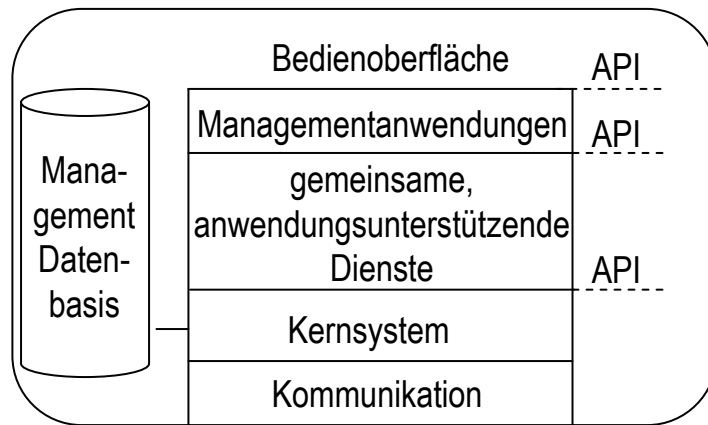

Agentensystem
(Managed System)

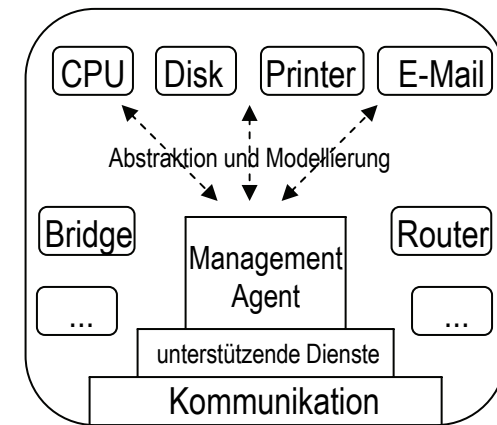

Managementplattform

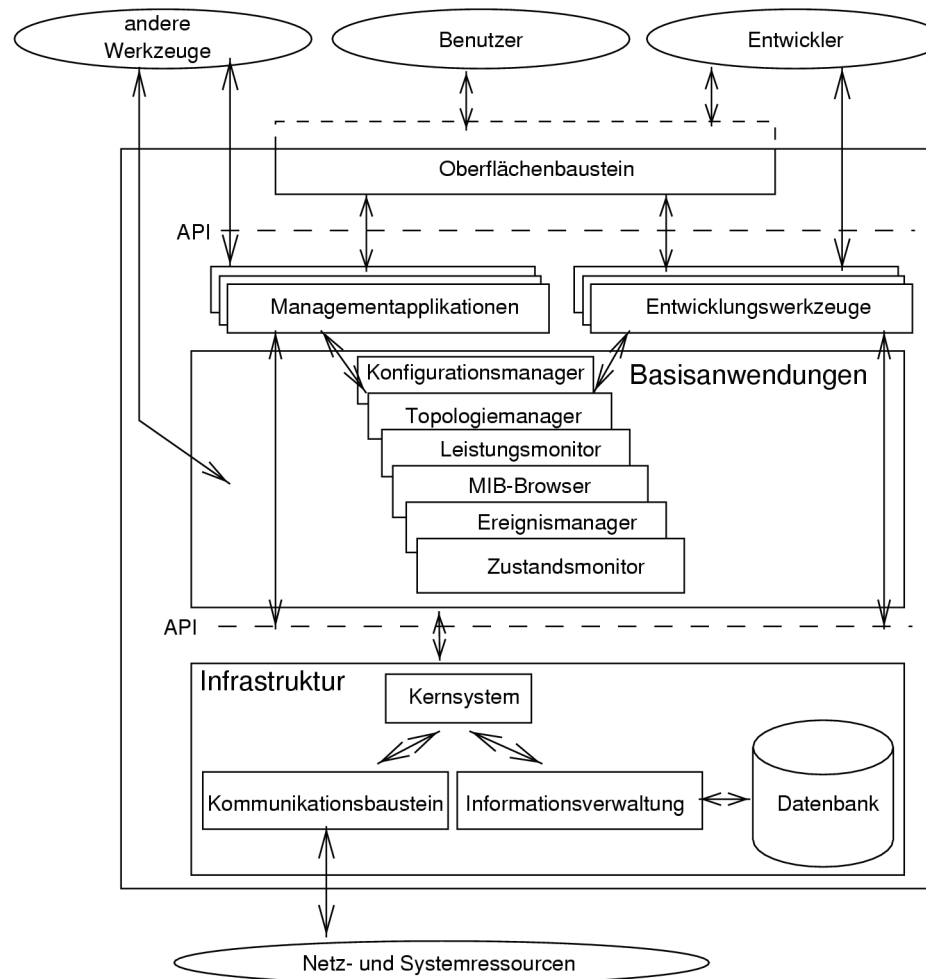

Architecture of Management Platforms

❑ Infrastructure components:

- Core system / kernel: coordination of ,all' other modules
- communication module: communication with remote systems
- Information module: OO management information base
- Interface module: network and system display and access to platform

❑ Basic applications:

- State management
- Event management
- Configuration management
- Topology management
- Performance management

❑ Development Tools

Infrastructure of a Management Platform

□ Communication module:

- provides services which permit access to information on on resources or other management stations.
 - Communication with resources via agents / proxies / brokers
 - Communication with (peer) management stations
- selection of the appropriate management protocol
- mapping of internal format to standardized format according to management architecture

Kommunikationsbaustein

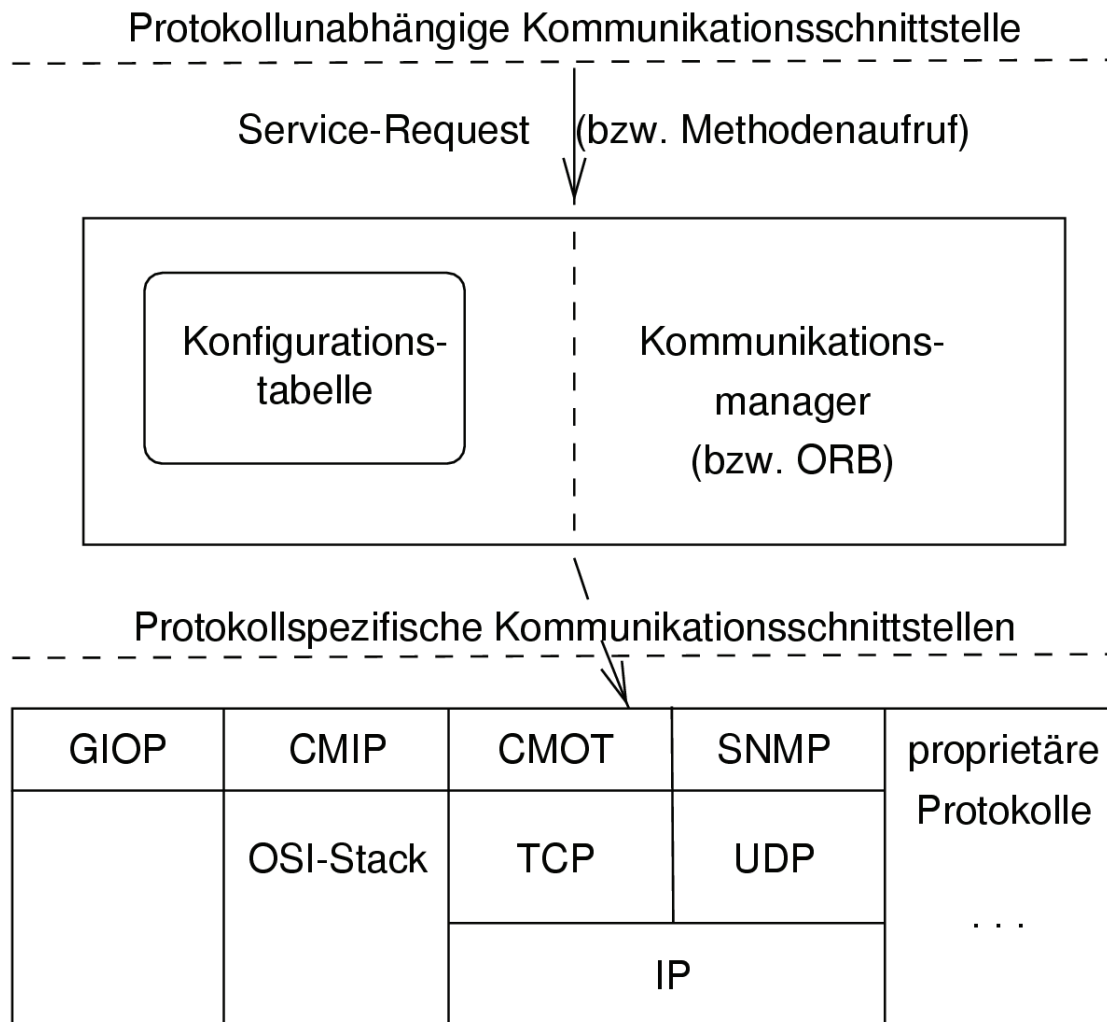

Informationsbaustein

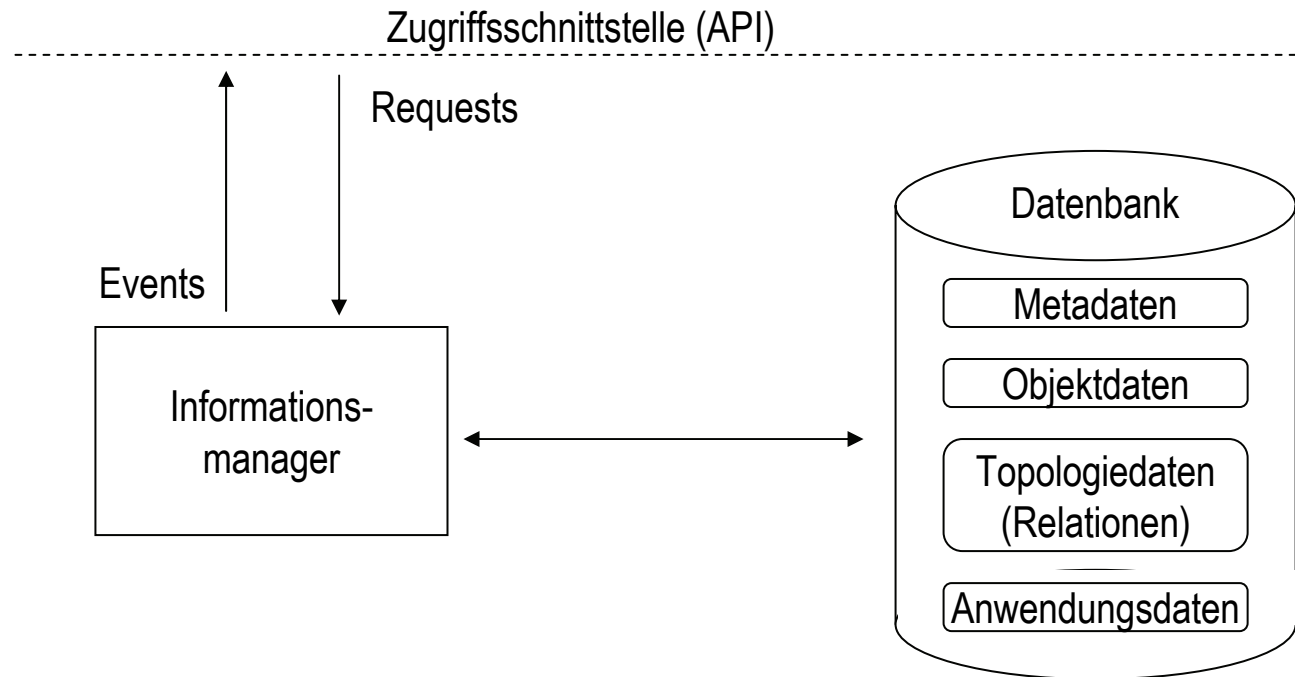

Infrastructure of a Management Platform

- ❑ Management and storage of management information:
 - alternative approaches
 - systems oriented (requires correlation of information)
 - network oriented (provides relationships)
 - underlying technologies
 - object-oriented databases
 - relational database systems
 - file-system based databases (e.g. flat files)
 - sources
 - MIB tools
 - discovery mechanisms
 - management applications
 - import from other tools and directories
 - by user interaction (e.g. graphical editor)

Benutzeroberfläche

☐ Aufgaben:

- Graphische Darstellung des Netzes
- Zugang zu Managementanwendungen
- Präsentation von Ergebnissen

☐ Funktionen:

- Verwaltung der Maps (Kreieren, Löschen, Sichern, etc)
- Editieren
- Lokalisieren
- Navigieren
- Aufruf von anwendungsspezifischen Diensten

User Interface

□ Basic principles:

- Object: represents a resource within the management platform, in accordance with the information model supported. Properties are modelled by corresponding object attributes. (e.g. systems, routers, software processes, buildings, regions)
- Symbol: graphical representation of an object within the user interface. An object can be represented by more than one symbol. (e.g. symbols for a fax server and a print server referencing a single workstation object)
- Submap: is a set of symbols which represent part of the IT infrastructure to be managed
- Map: is a set of hierarchically related submaps representing the entire IT infrastructure to be managed for the user.

Benutzeroberfläche

Aufbau einer Map:

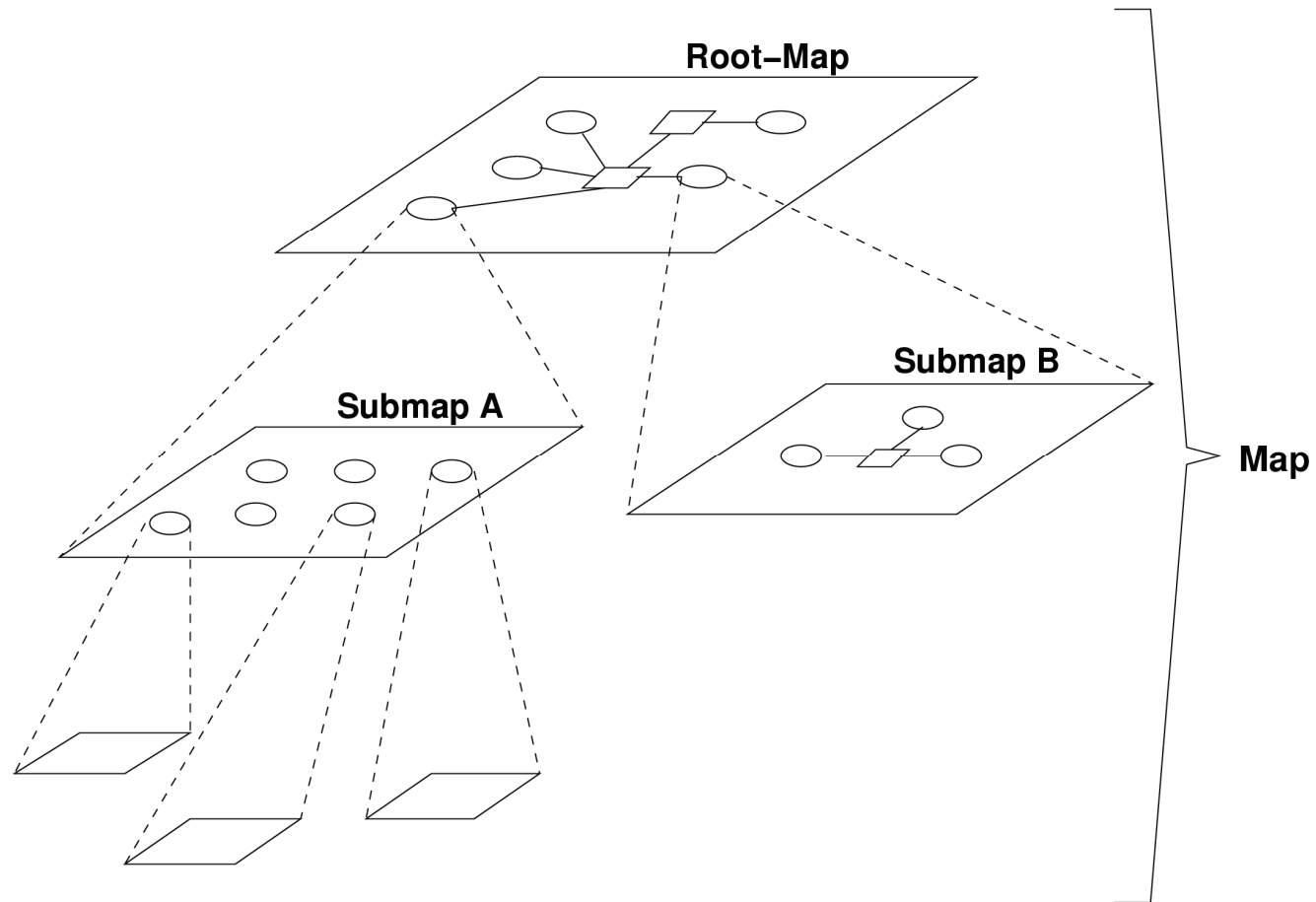

User Interface

Kap. 09

Mgmt. vernetzter IT-Systeme

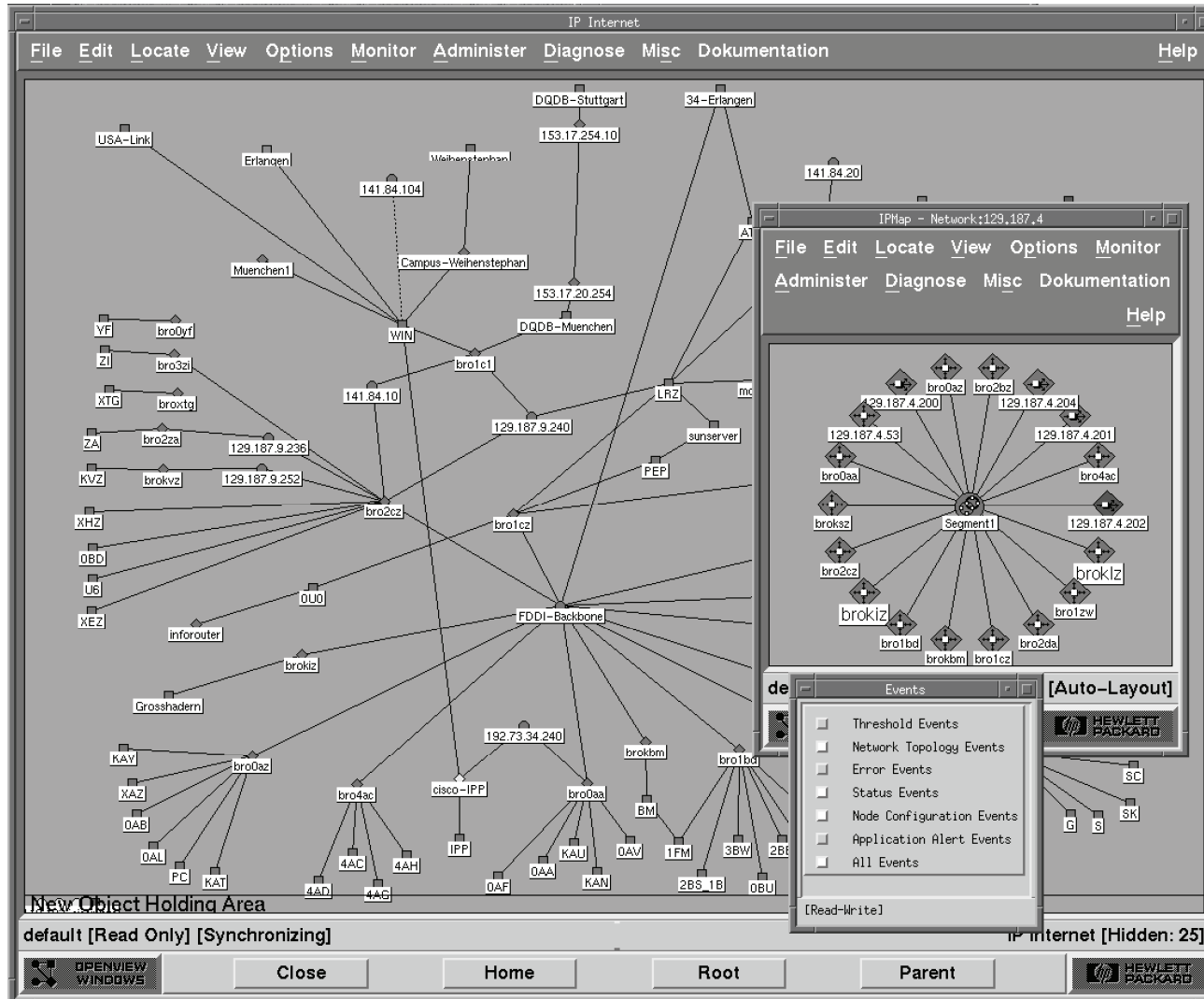

User Interface

□ Views:

- structured representation of resources,
- according to different criteria (e.g. technology, topology, functionality),
- user specific and usage specific interpretation of resources

□ Definition:

A view can be described as a tuple consisting of:

- a set of symbols, hierarchically arranged in submaps
- a set of functions which are applied to the symbols and the underlying objects,
- a set of users with access rights to the submap hierarchy, functions, and objects.

Benutzeroberfläche

Bereitstellung verschiedener Views:

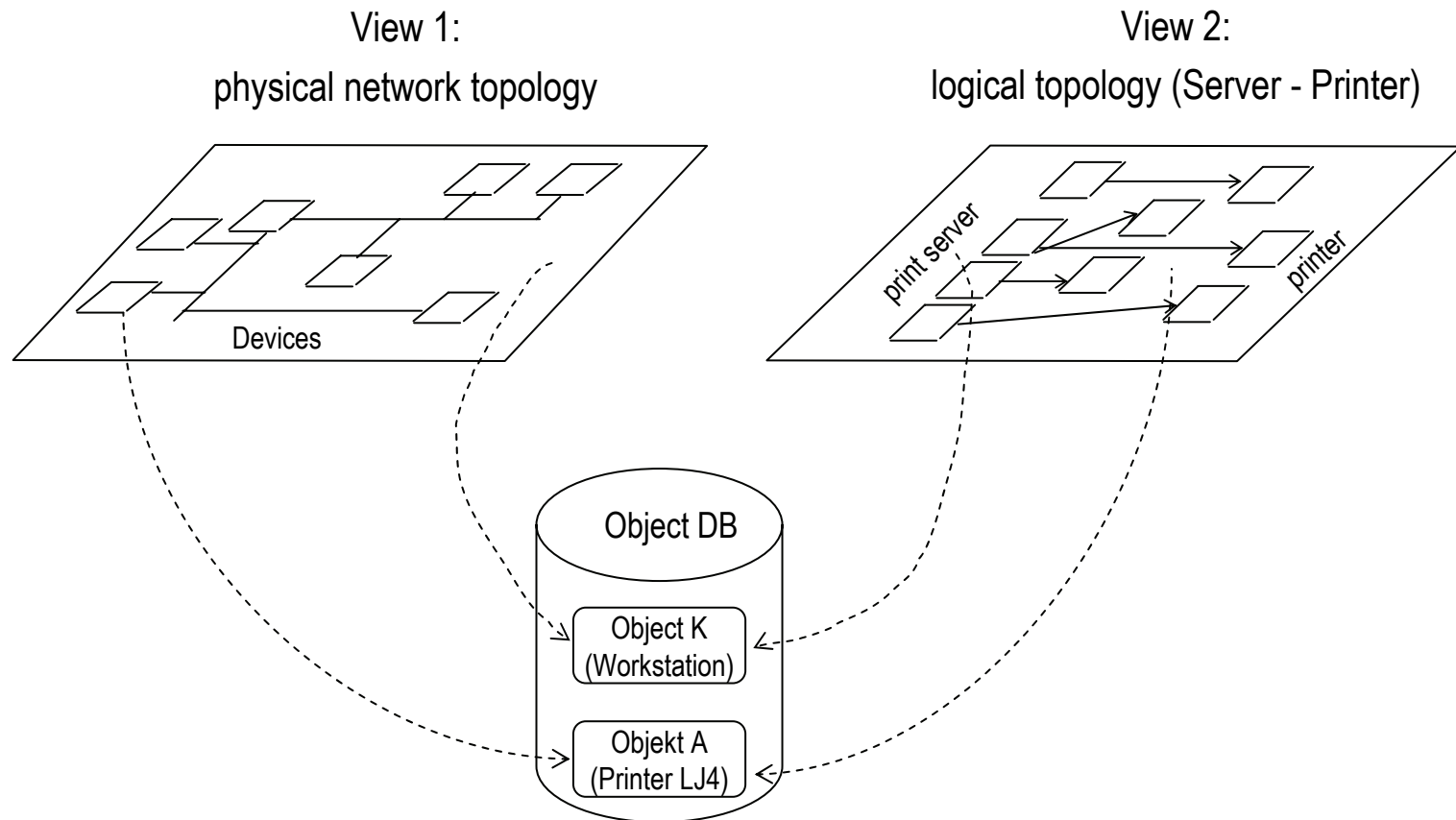

Mgmt-Platform: Basic Applications

- ❑ Examples of basic applications found in management platforms:
 - State monitor
 - Threshold monitor
 - Event manager
 - Configuration manager
 - Topology manager
 - Performance manager

Basic Applications: State Monitor

□ Methods:

- polling with ICMP (echo & test protocol)
- SNMP monitoring (e.g., MIB II)
- connecting oriented management (CMOT)

□ Disadvantages of polling

- insecure datagrams
 - overloaded systems do not respond
 - delay within the network
- timeouts and retry counter

CNM für das MWN - Backbone

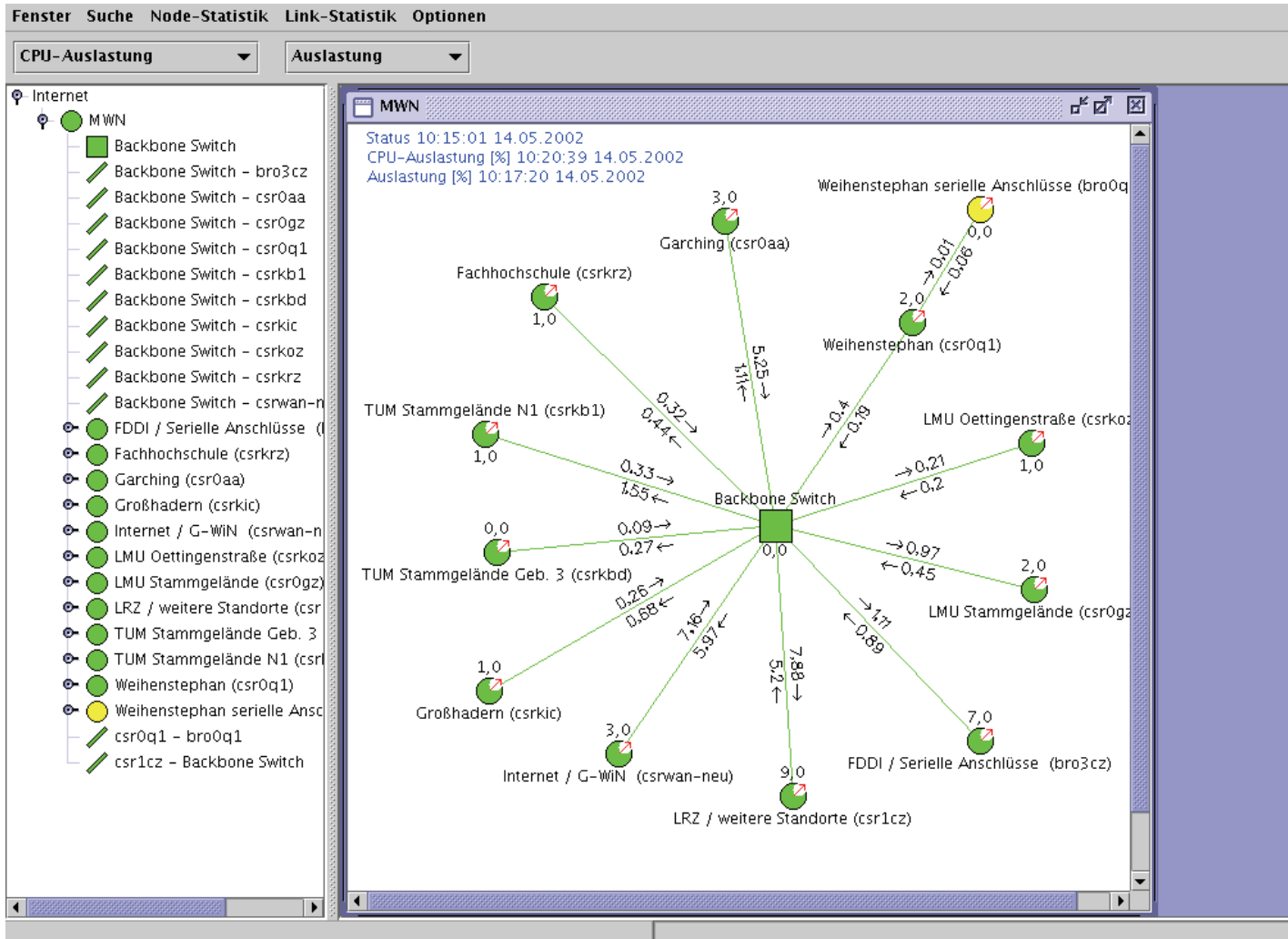

CNM für das MWN - GWiN Anbindung

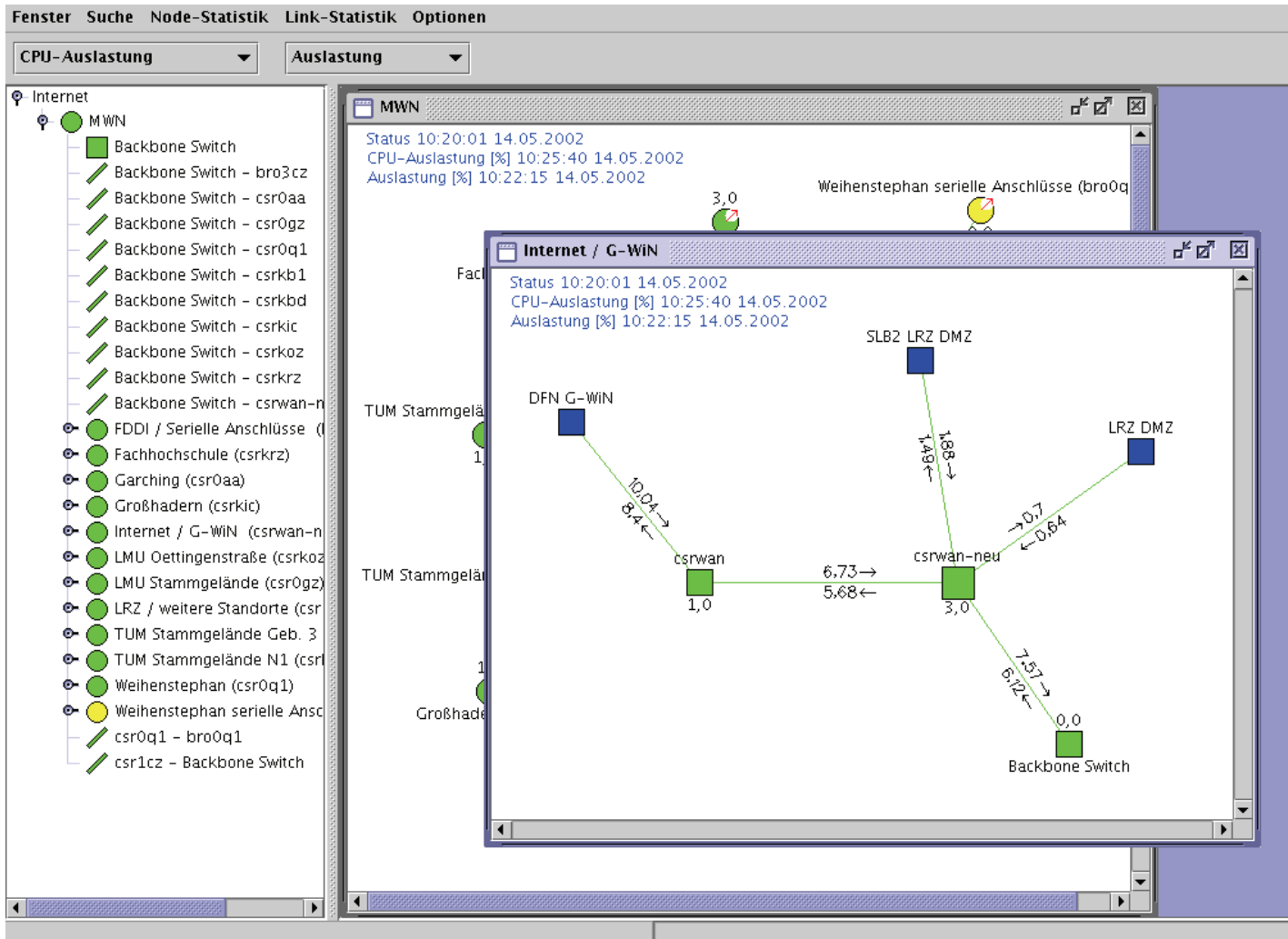

Basic Applications: Threshold Monitor

❑ Methods:

- SNMP: → thresholds defined, managed, and monitored within the management station, (but RMON).
- CMIP: → thresholds defined, managed, and monitored in managed systems!

❑ Threshold monitoring requires the definition of:

- measurement points within a system
- polling intervals
- a threshold
- a condition upon which an event should be generated

Basic Applications: Event Management

□ Functionality:

- storage and filter-controlled analysis of events
- conversion of events into device related states
- reporting of events to users (optical or acoustic)
- distribution of events to (management) applications
- correlation of events
- execution of actions

□ Reactions to the arrival of events:

- sending email, automatic call, voice mail, etc.
- starting specific diagnostic actions
- creation of fault information, e.g., a trouble ticket
- calling UNIX commands

Basic Applications: Event Management

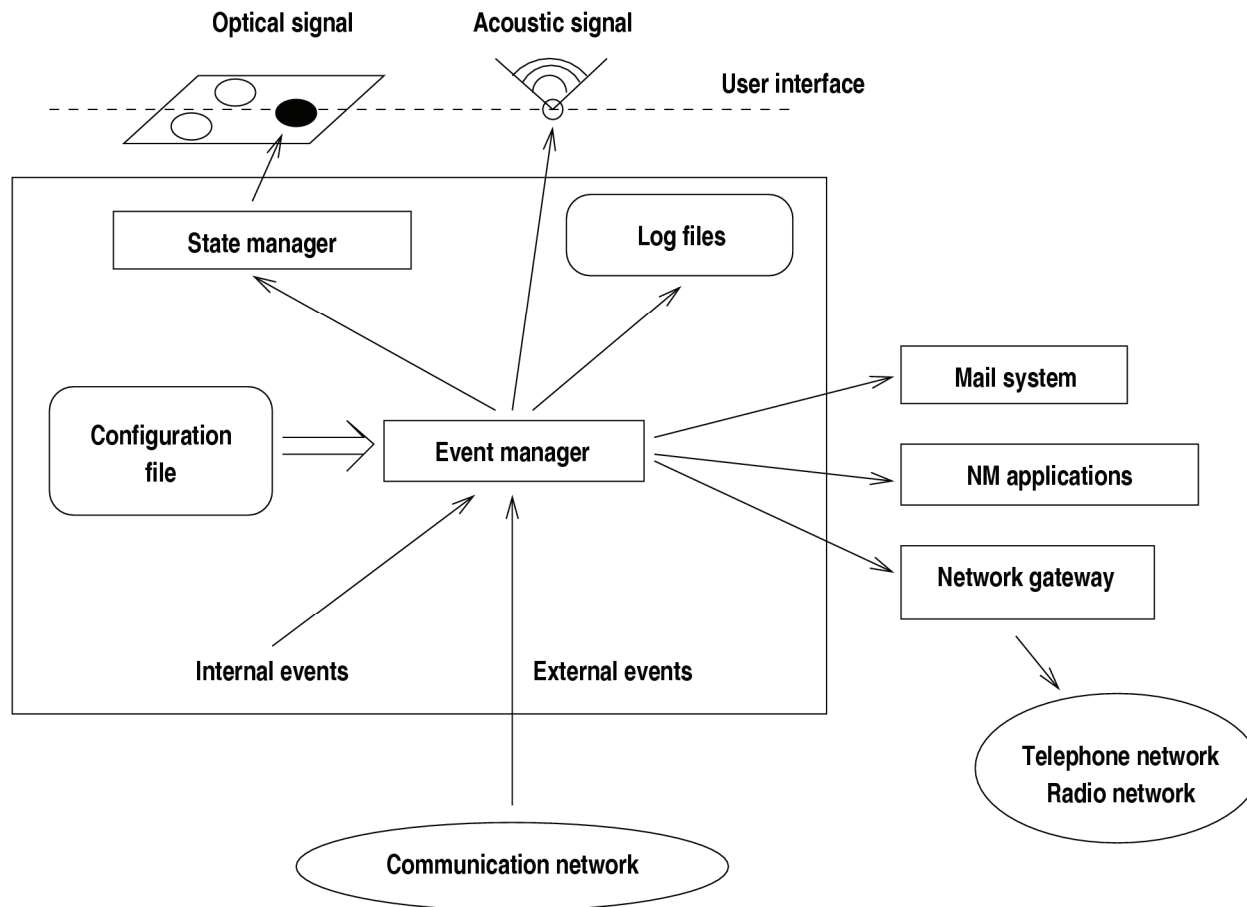

Basic Applications

□ State model for event management:

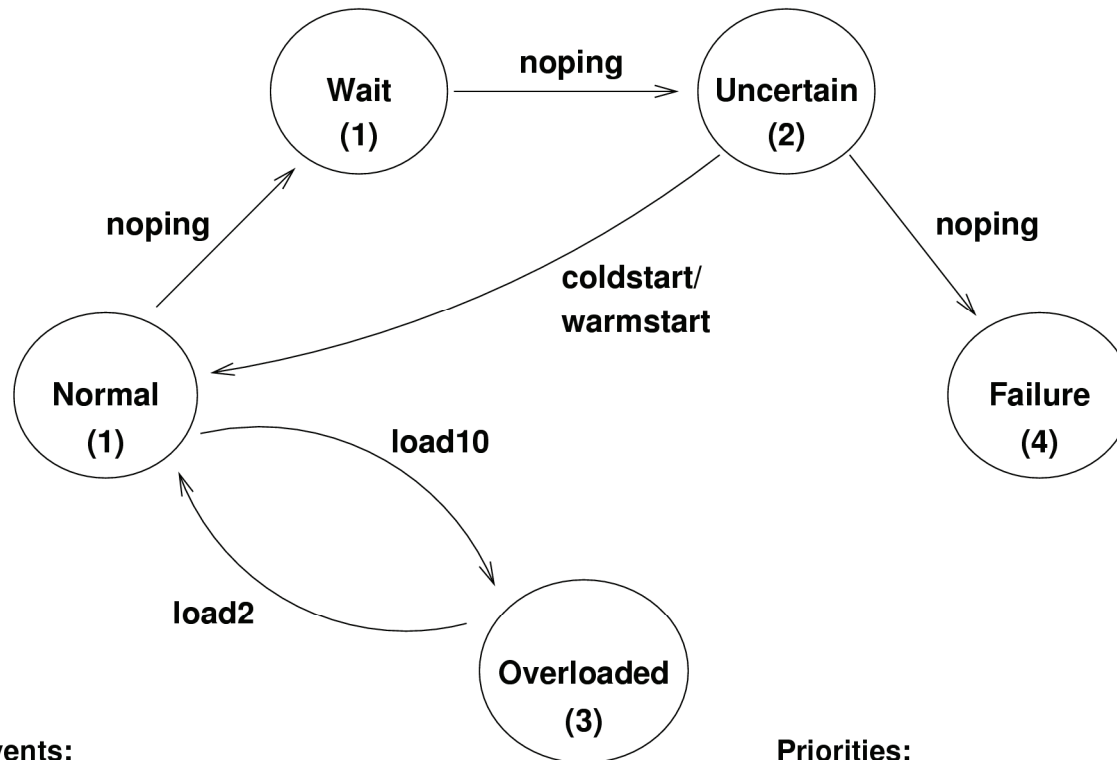

Events:

- noping: No answer to ping within 10 sec
- coldstart/warmstart: Trap is on
- load10: Load is over 10
- load2: Load is under 2

Priorities:

- normal (1)
- low (2)
- medium (3)
- high (4)

Basic Applications: Configuration

❑ Configuration applications:

- provide the user with WRITE access to resources

❑ Types of configuration applications:

- Information about the current configuration of resources
- Alteration of the configuration using management protocols
- Configuration by dialling into remote systems
- Configuration using vendor-specific modules

Basic Applications: Topology Mgmt

- ❑ Topology manager:
 - collects and structures configuration information
 - builds topology maps
- ❑ Discovery techniques:
 - access to config. tables in devices (e.g. routing tables)
 - testing of the protocols supported by newly discovered devices
 - use of echo protocols (e.g. ICMP, Traceroutes)
 - use of information obtained using protocol analysers
 - use of information services (NIS, DNS, etc.)
 - use of MIBs
- ❑ Important:
 - discovery restrictions (to subnetworks, by boundary systems)

Anwendungen: Topologie-Management

- ❑ Sammeln von Informationen über Systeme (Auto-Discovery)
- ❑ Generieren einer Netztopologie (Auto-Topologie)

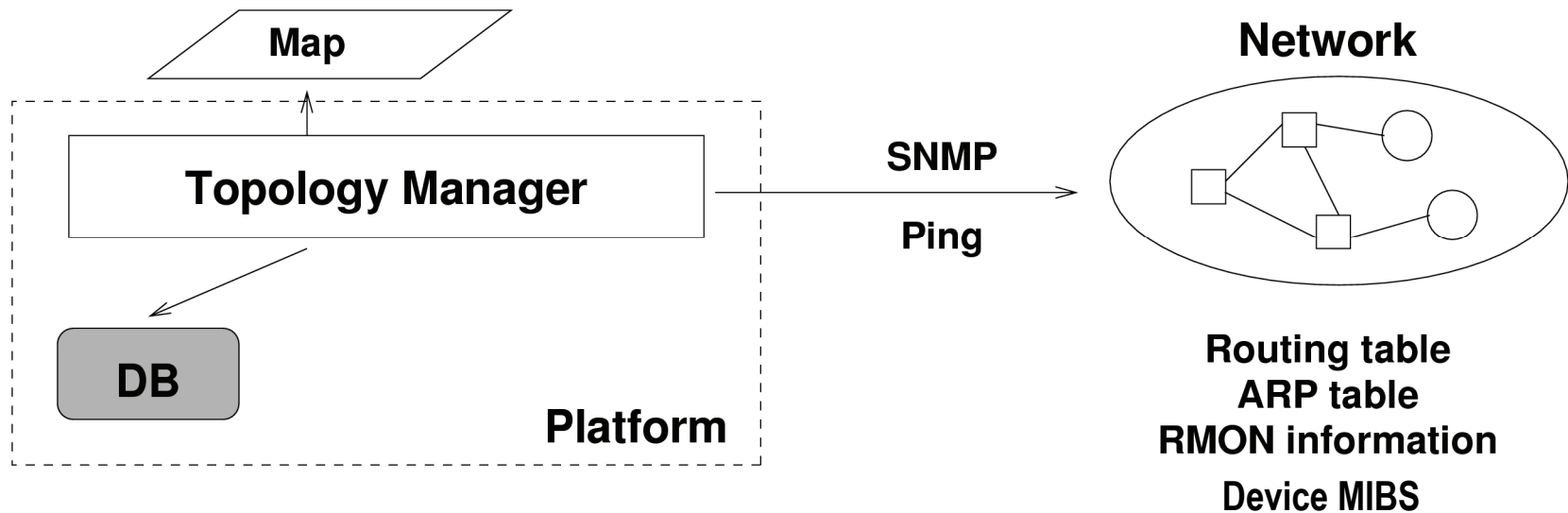

Basic Applications: Performance Monitor

similar to threshold monitors:

- selection of measurement points by specifying a system and the attributes to be measured
- specifying measurement intervals, i.e. the sampling rate
- defining measurement duration, start time and/or stop time
- analyzing performance data
- displaying results
- possibility triggering events

Plattform-basierende Netzmanagement-Produkte

- ❑ HP OpenView Network Node Manager (Datenkommunikation)
HP OpenView TeMIP Framework / HP OpenCall (Telco, OSS)
 - Manager-to-Manager-Kommunikation, Verteilung durch Replikation von Event- und Topologieinformation, Event-Korrelation (ECS), größter Marktanteil
- ❑ SunSoft Solstice Domain/Site und Enterprise Manager (Telco)
 - Verteilung durch Replikation von Event- und Topologieinformation, JMAPI, verteilte Management-Konsolen, Event-Korrelation (NerveCenter-Technologie)
- ❑ Aprisma's Spectrum
 - Model-basierter Ansatz (IMT), objekt-orientiert, AI-Techniken (MBR, CBR), innovativer Ansatz, Trend-Analysen, Event-Korrelation, Spectrum Service Manager
- ❑ Tivoli NetView (SNMP), Tivoli NetView für OS/390
 - Event-Korrelation, hierarchisches Management (Mid-level-Manager), Policy-based-Management, SmartSets, User-Defined Discovery

Plattformen/Managementanwendungen

Beispiel Solstice Enterprise Manager

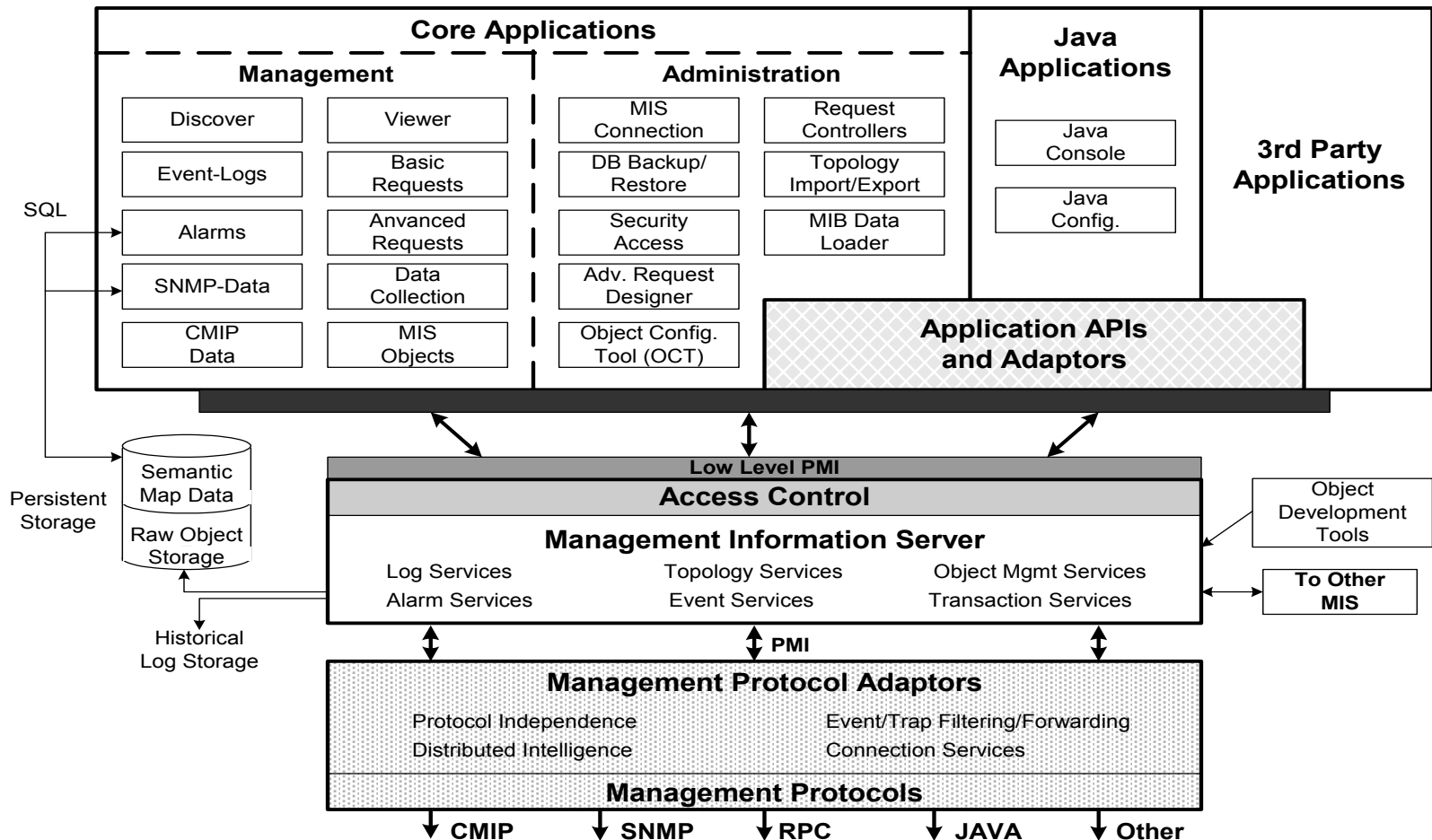

Plattform-basierende Systemmgmt-Produkte

- ❑ HP OpenView Operations für Unix/Windows, IT Administration
 - Überwachung von Systemressourcen (Prozesse, Plattenplatz), Benutzerverwaltung, File/Server/Drucker-Mgmt, innovativer Ansatz im Bereich der Agenten-Technologie, IT-Umgebung aus Sicht von Geschäftsprozessen
 - HP OpenView Integrated Service Management: Portfolio diverser Produkte wie z.B. Service Activator / Navigator / Quality Manager
- ❑ IBM Tivoli Enterprise
 - Framework-Ansatz, CORBA-Basis (nicht 2.0), hohe Skalierbarkeit, Integration von „Third Party“-Produkten
 - Beispiele von Modulen: IBM Tivoli Business Systems Manager, IBM Tivoli Monitoring, IBM Tivoli Enterprise Console (Event-Korrelation), IBM Tivoli Service Level Advisor, IBM Tivoli Configuration Manager, IBM Tivoli Identity Manager, IBM Tivoli Intrusion Manager
- ❑ CA Unicenter TNG/TND
 - Aufbau eigener Technologie durch Kauf und Re-Engineering, Real-World Interface, Neuagents, Business Process Views (2D, 3D), auch Netzmanagement (NetworkIT), IT Ressource Management

Plattform/Managementanwendung

Beispiel Tivoli Enterprise:

- Systemmanagementplattform
 - CORBA –Middleware
 - Neue Architektur („Tsunami“): hohe Skalierbarkeit, einfacheres Customizing, „Endpoints“, „Gateways“, „Endpoint Managers“

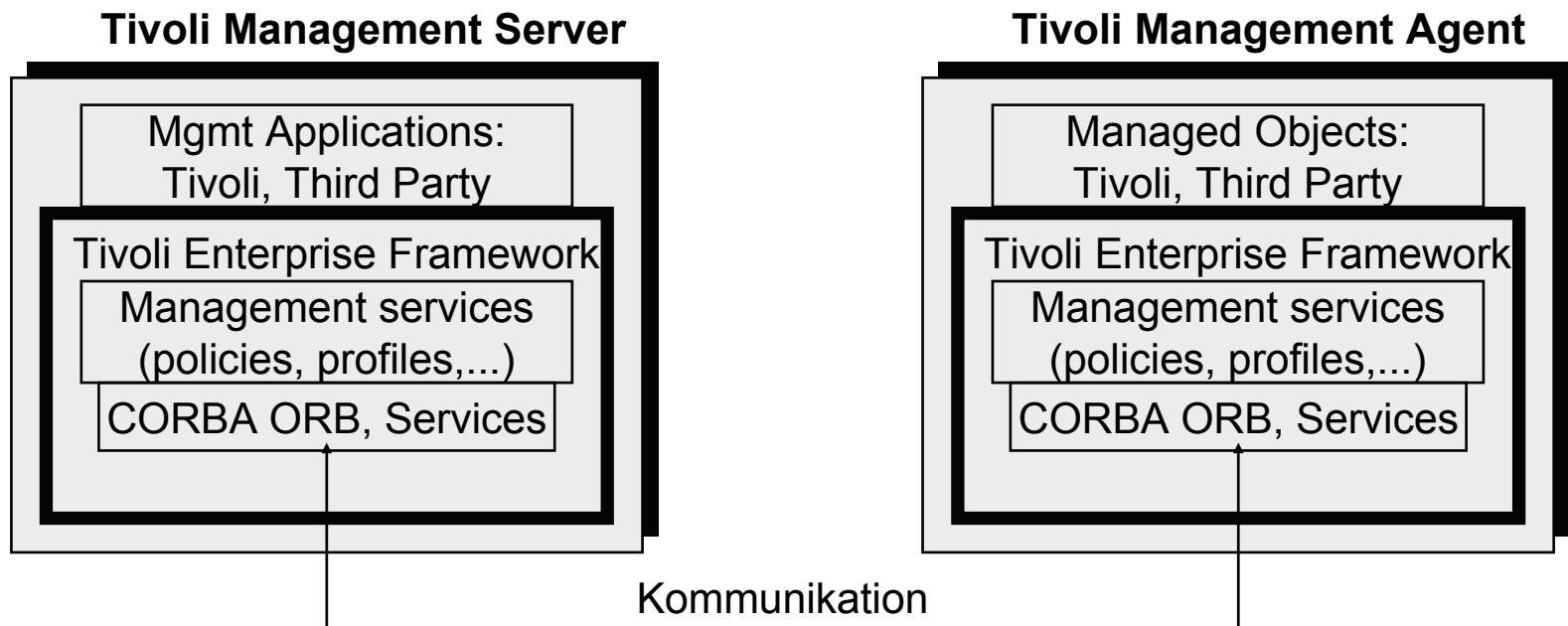

Plattformen/Managementanwendungen: Beispiel Tivoli Enterprise Architektur

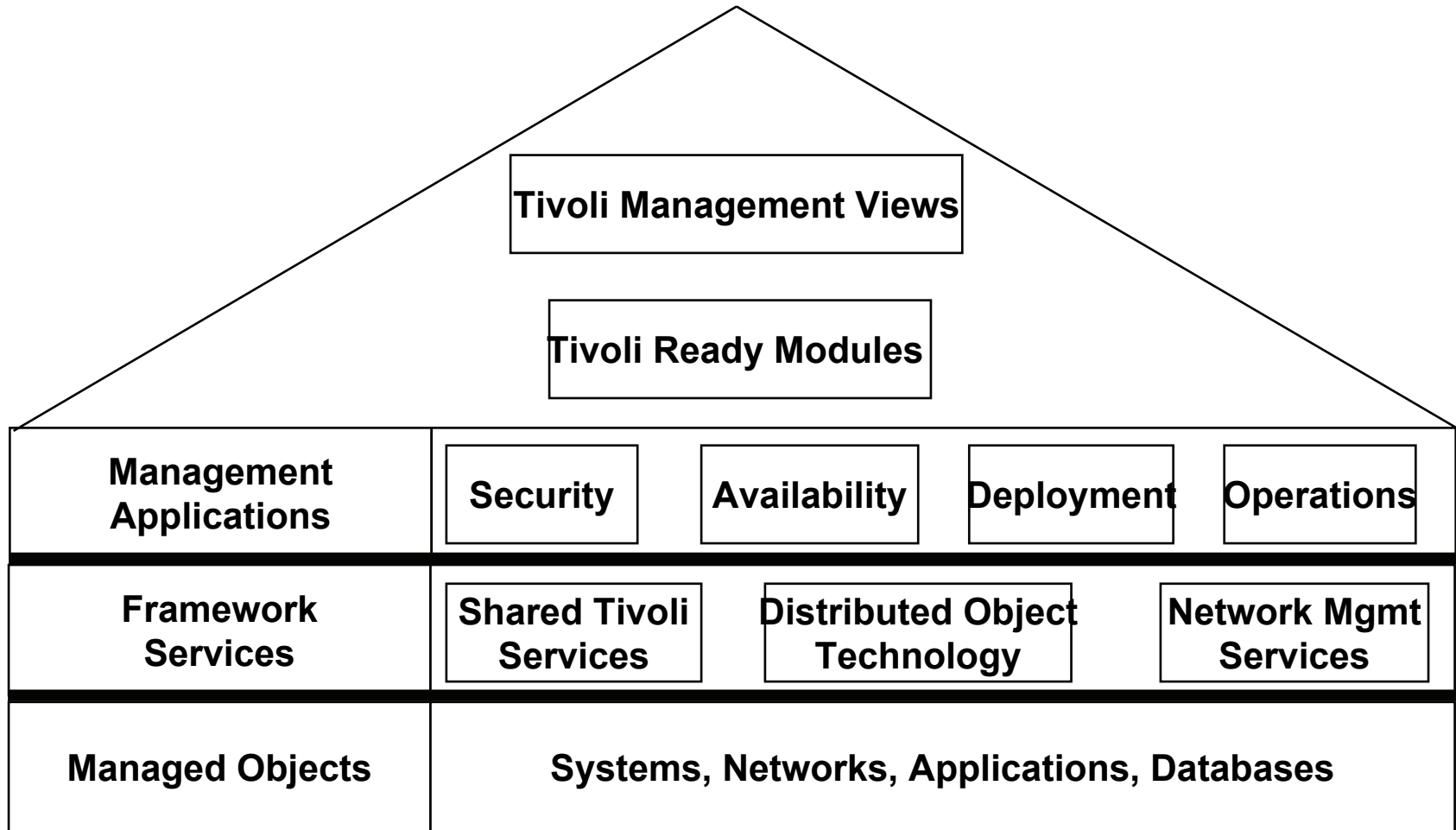

Beispiele von kommerziellen Managementplattformen: Tivoli Enterprise Module

- ❑ Beispiele von Modulen für Systemmanagementaufgaben
 - IBM Tivoli Enterprise Console: Event-Korrelation
 - IBM Tivoli Monitoring: Überwachen von Ressourcen
 - IBM Tivoli Configuration Manager: Mgmt von SW/Patches
 - IBM Tivoli Service Level Advisor: Service Level Management
 - IBM Tivoli Storage Manager
- ❑ Beispiele von Anwendungsmodulen
 - IBM Tivoli Monitoring for Applications (SAP R/3, Siebel)
 - IBM Tivoli Monitoring for Business Integration (IBM Websphere MQ)
- ❑ Entwicklungsmodule
 - Tivoli Module (Kreierung von Mgmt-Anwendungen auf Basis von AMS), Tivoli Plus Module für die Integration mit 3rd Party Produkten
- ❑ Business View
 - IBM Tivoli Business Systems Manager

Tivoli Mgmt Software Product Suite (1)

❑ Business Service Management

- Ganzheitliches Management von Anwendungen, Prozessen, Systemen, Netz
 - u.a. *Tivoli Business Systems Manager, Tivoli Enterprise Console, Tivoli NetView, Tivoli Service Level Advisor, Tivoli Web Site Analyzer*

❑ Infrastruktur Orchestrierung

- Effiziente, zeitgerechte Zuordnung von Ressourcen zu Geschäftsprozessen und Diensten
 - *Tivoli Intelligent Orchestrator*

❑ Verfügbarkeit

- Sicherung der Leistungsfähigkeit und Effizienz der IT-Umgebung
 - u.a. *Tivoli Monitoring, Tivoli Web Response Monitor, Tivoli OMEGAMON* (Candle-Suite für Überwachung von Anwendungen)

Tivoli Mgmt Software Product Suite (2)

❑ Security

- Gewährleistung der Vertraulichkeit und Integrität der Informationsressourcen
 - u.a. *Tivoli Intrusion / Risk / Access / Privacy Manager*

❑ Storage und Optimierung

- Speicherung von Daten
 - *IBM TotalStorage Open Software Family*

❑ Provisioning

- Zuordnung von Ressourcen zu Prozessen abhängig von Service-Levels (Ergänzung zur Orchestrierung)
 - u.a. *Tivoli Provisioning Manager, Tivoli License Manager, Tivoli Configuration Manager*

HP's OpenView Family of Mgmt Products (1)

- ❑ Beispiele der Produkte (komplette Liste unter <http://www.openview.hp.com/products/a-z.html>)
- ❑ *Business Process Insight*: Darstellung der Geschäftsprozesse, Impact Analyse
- ❑ *Event Correlation Services*: Event-Korrelation
- ❑ *Extensible SNMP Agent*: Erweiterung der SNMP-Funktionalität
- ❑ *IT Administration*: zentralisierte Administration von Benutzern, Systemen und Software in heterogenen Umgebungen
- ❑ *Network Node Manager*: Überwachung der Netzkomponenten
- ❑ *Operations für Unix / Windows*: Überwachung der Endsysteme

HP's OpenView Family of Mgmt Products (2)

- ❑ *Performance Insight mit Service Quality Manager*: Service-Level-Management Tool
- ❑ *Service Activator / Service Navigator*: Einführung von Diensten, Darstellung der Event-Information auf der Dienstebene
- ❑ *Service Desk*: Trouble-Ticket-System
- ❑ *Smart Plugin-Ins*
- ❑ *Storage-Family*: Speicherung von Daten
- ❑ *Web Transaction Observer*: Überwachung von Reaktionszeiten des Zugriffs auf Web-Seiten

Beispiele von dedizierten Werkzeugen

❑ Komponentenspezifische Werkzeuge

- CiscoWorks2000 von Cisco
- HP ProCurve Manager
- OPTX von Ciena (WDM-Management), MegaVisionWeb von MRV (SNMP-basiertes WDM-Management)

❑ Event-Management-Werkzeuge

- Netcool von Micromuse (Probes)
- PATROL von BMC Software (grosse Palette von Agenten, zentralisierte Kontrolle aller relevanten Elemente eines verteilten Systems)

❑ Problemmanagement-Werkzeuge

- Action Request System von BMC Remedy
- Service Desk von Peregrine Systems
- HP Service Desk

Beispiele von dedizierten Werkzeugen

- ❑ Service-Level-Management-Werkzeuge (Datensammlung, Reporting, Dienst-Sicht)
 - InfoVista von InfoVista
 - NetworkHealth von Concord
 - PROVISIO von Quallaby
 - Visual Up Time Select / IP InSight von Visual Networks
 - VitalSuite von Lucent
 - SiteAngel von BMC Software (Tests des Zugriffs auf Web-Seiten)
 - Aprisma's Spectrum Dominion
 - Enterasys NetSight
- ❑ Netzanalyse-Werkzeuge (Anwendungsüberwachung)
 - Vantage von Compuware (Probes)
 - NetScout's Unified Performance Management Solution (NetScout Probes, nGenius Performance Manager)

Asset/Facilitymanagement-Werkzeuge

❑ Asset-Management

- Funktionalität: Haltung, Darstellung und Sammlung von Informationen über Assets (z.B. PCs, Workstations, Netzkomponenten)
- Update der Informationen durch sog. “Autodiscovery”-Werkzeuge wie z.B. iInventory’s LANauditor (freeware)
- Beispiele von Produkten: IBM Tivoli Asset Management, PeopleSoft Asset Management

❑ Facility-Management

- Gebäude- und Kabelmanagement, Netzplanung, -dokumentation, -verwaltung
- Integration mit Managementplattformen, TTSs
- Beispiele von Produkten: Allplan von Nemetschek

Firewalls

- ❑ Ziel: Schützen des verteilten Systems vor Angriffen und Missbrauch
- ❑ Realisiert als Hardware und/oder Software
- ❑ Funktionalität:
 - statischer Packet Filter (eingeschränkte Regeln auf Router)
 - dynamischer Packet Filter (benutzerbezogene und zeitabhängige Filterregeln auf Routern)
 - Application Gateway (eigenständige HW, zusätzlich Authentisierung und Verschlüsselung)
 - Screened Subnet (Application Gateway mit vor- und nachgeschaltetem Packet Filter)
- ❑ Produkte: Cisco PIX Firewall (Packet Filter), CheckPoint Firewall-1

Event-Korrelationswerkzeuge

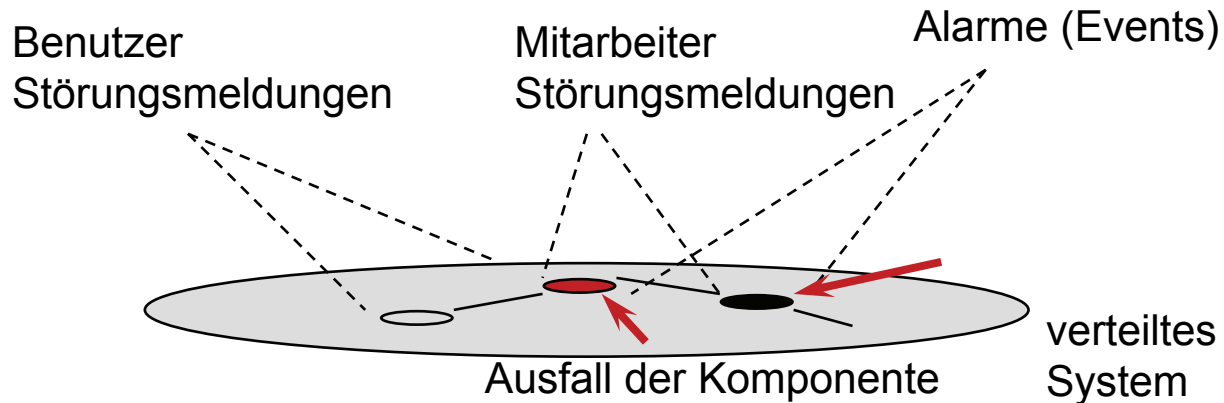

- Ein Fehler - viele Events, verschiedene Störungsmeldungen (Benutzer, Mitarbeiter);
 Propagation von Fehlern → **Anstatt vieler DATEN nur relevante INFORMATIONEN an Operateure/Experten**
- Event-Korrelation, automatische Generierung von Trouble-Tickets aus korrelierten Events
- Beispiele von Produkten: IBM Tivoli Enterprise Console, HP ECS, SMARTS InCharge